

Aquacom[®] SSB-2010 SSB-1001B

Single Sideband Acoustic Telephone

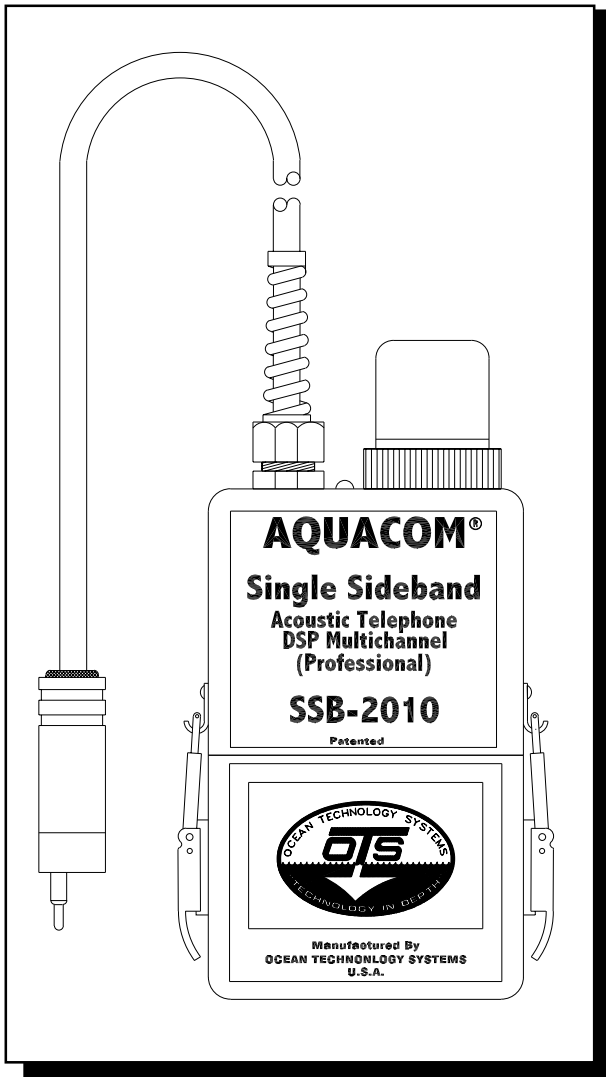

"Why Wait to Communicate"

- IMPORTANT SAFETY NOTICE -

(Please read before using the product)

It is absolutely essential that all divers be properly trained and equipped and fully understand this owner's manual before attempting to use the Aquacom[®] SSB series of transceivers.

While Aquacom[®] provides divers with good underwater communications, it does not change or eliminate the potential hazards of diving!

- NOTE -

This manual and the information contained herein are provided for use as a maintenance and operation guide. No license or rights to manufacture, reproduce, and/or sell either the manual or the articles described herein are given. Ocean Technology Systems reserves the right to change specifications without notice.

TABLE OF CONTENTS

<u>Section</u>	<u>Title</u>	<u>Page</u>
1	Introduction	1
1.1	General	1
1.2	Specifications	2
2	Equipment Description	3
2.1	General Description	3
2.2	Package Design	3
2.3	Transceiver Adjustments	3
2.4	Voice-Operated Transmitter (VOX)	4
2.5	Manual Push-to-Talk Switch (PTT)	4
2.6	Squelch	5
2.7	Side Audio Volume	5
2.8	Receiver Volume	5
2.9	Multiple Channel Selection	5
2.10	Related Components	6
2.10.1	Transducer	6
2.10.2	Earphone/Microphone Module (EM)	7
2.10.2.1	EMA-2 Earphone/Mic. Assembly (911060-001)	8
2.10.2.2	EMA-2SM Earphone/Mic. Assembly (911060-098)	8
2.10.2.3	EMX-2 Earphone/Mic. Assembly (911060-008)	8
2.10.2.4	EMX-2B Earphone/Mic. Assembly (911060-026)	8
2.10.2.5	EMO-2 Earphone/Mic. Assembly (900096-686)	8
2.10.2.6	EMH-1 Earphone/Mic. Assembly (911060-009)	8
2.10.2.7	EMS-2 Earphone/Mic. Assembly (911060-017)	8
2.10.2.8	EMMT-1 Earphone/Mic. Assembly (911060-090)	8
2.10.2.9	EMMT-2 Earphone/Mic. Assembly (911060-091)	9
2.10.2.10	EMD-2 Earphone/Mic. Assembly (911060-067)	9
2.10.2.11	EMDG-2 Earphone/Mic. Assembly (911060-076)	9
2.10.2.12	EMH-MAG2 Earphone/Mic. Assembly (900332-000)	9
2.10.2.13	LAR-V® Adapter Assembly (900282-000)	9
2.11	Microphones	9
2.11.1	ME-16R Hot-Mic®	9
2.11.2	Super Mic® Depth Master	10
2.12	Compatible Surface/Diver Transceivers	10
3	Adjustment & Operating Instructions	11
3.1	Inspection of Equipment	11
3.2	Aquacom SSB Operating Procedures	11
3.3	Adjusting the SSB-1001/2010	13
3.3.1	Voice Adjustment Mode	13

3.3.2	Push-to-Talk (PTT) Button	13
3.3.3	Transmit Adjustment	14
3.3.3.1	VOX Adjustment	14
3.3.3.2	PTT Adjustment	14
3.3.4	Channels	14
3.3.5	Squelch Adjustment	14
3.3.6	Volume Adjustment	15
3.3.6.1	Side Audio Adjustment	15
3.3.6.2	Receive Volume	15
3.4	CDK-6 Surface Accessory Kit	15
3.4.1	Installation of the CDK-6	16
3.4.2	Push-to-Talk Mode	16
3.4.3	VOX Mode	16
3.5	Pre-Dive Checklist	17
3.6	Receiving a Message	18
3.7	Doffing the Diver Units	18
3.8	Examples of Underwater Communications	18
3.8.1	Calls Between Surface, Subs, or Divers	18
3.8.2	Calls Between Divers and Surface, Subs, or Bells	19
3.8.3	Calls Between Surface Units, Subs, and Bells	19
4	Battery Installation & Charging	20
4.1	SP-8, AA Alkaline Battery Holder	20
4.2	RB-11 NiMH Battery Pack and RC-15 Charger	20
5	Maintenance & Helpful Hints	22
5.1	General Maintenance	22
5.2	Periodic Maintenance	22
5.3	Helpful Hints	22
6	Advanced User Information	24
6.1	General	24
6.2	VOX	24
6.3	Squelch	25
7	Basics of Sound In Water	27
7.1	Background	27
7.2	Factors That Affect Sound in Water	27
7.2.1	Distance	27
7.2.2	Water Density	28
7.2.3	Water Temperature	28
7.2.4	Background Noise	29
7.2.5	Zones of Silence	29
	Limited Warranty	32

SECTION 1

INTRODUCTION

Congratulations! You have just purchased the finest, state-of-the-art, patented underwater communication system available. The Aquacom[®] SSB-1001B and SSB-2010 are ultrasonic, single-sideband transceivers designed to allow diver-to-diver and diver-to-surface through-water voice communications. They employ *Digital Signal Processing* (DSP) techniques, which ensure the highest-quality intelligibility possible. Standard features include automatic electronic switching, allowing the diver total function control underwater; voice menu; dual earphones with holders; separate volume controls for receiving and audio monitoring; voice activation (VOX) and Push-to-talk (PTT) modes; multiple channels; a heavy-duty housing; and more! In all, the SSB-1001B and SSB-2010 are second to none!

1.1 GENERAL

This manual contains information regarding the Aquacom[®] SSB-2010 and SSB-1001B underwater communication systems, including all earphone/microphone assemblies and support equipment.

The SSB-2010 with optional EMA-2 earphone/microphone assembly is depicted in Figure 1.

Figure 1

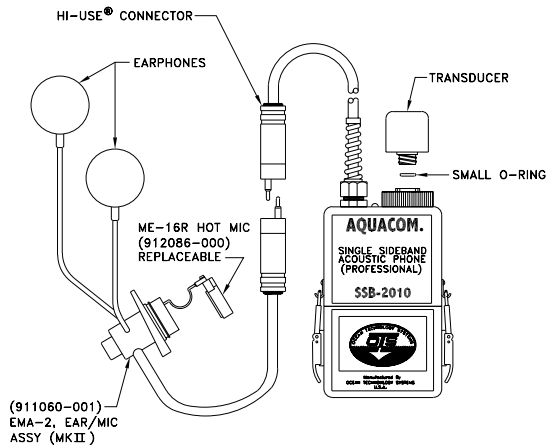

1.2 SPECIFICATIONS

Nominal Range:	Calm Sea: Greater than 1000 meters nominal Sea State 6: 200 meters nominal
Acoustic Output Power:	SSB-2010: 3 watts (176.2 dB re 1 mPA at 1 meter) SSB-1001B: 5 watts (178.2 dB re 1 mPA at 1 meter)
Audio Frequency Response:	300–4000Hz
Receiver Sensitivity:	–110 dBv
Automatic Gain Control:	120 dB dynamic range
Transmitter Activation:	Voice-operated transmitter (VOX) or manual activation (PTT)
Transmitter Band:	SSB-2010: 31–33 kHz; SSB-1001B: 25–33 kHz
Battery Type:	8 AA alkaline cells or RB-11 nickel metal hydride battery
Battery Life:	AA alkaline batteries: 7 hours for the SSB-2010 and 6 hours for the SSB-1001B, assuming a 10% transmission cycle. RB-11 nickel-metal hydride, rechargeable batteries: 13 hours, assuming a 10% transmission cycle*.
Transducer:	Piezoelectric type
Earphone:	Ceramic type (standard on most FFM's)
Housing:	Injection-molded, high-impact, glass-filled ABS plastic
Maximum Depth:	500 ft.
Housing Dimensions:	Height: 7.60", Width: 3.55", Depth: 1.80"
Operating Temperature:	0° C to 60° C (32° F to 140° F)
Storage Temperature:	–10° C to 60° C (–14° F to 140° F)
Low Battery Indication:	Red LED on upper housing
Connector Type:	Hi-Use®

* See the note on page 20.

SECTION 2

EQUIPMENT DESCRIPTION

2.1 GENERAL DESCRIPTION

The Aquacom® SSB-2010 and SSB-1001B are housed in a watertight enclosure designed for easy belt or tank mounting. For surface operation (diver-to-surface or vice versa) the user has the option to utilize the CDK-6 Surface Accessory Kit, Aquacom® STX-101, STX-101M, SP-100, or Magnacom® MAG-1001S portable surface stations.

2.2 PACKAGE DESIGN

The Aquacom® SSB housing is constructed of high-impact, glass-reinforced ABS plastic, which will not corrode if scratched.

The housing is divided into two major parts: the upper electronics and the lower battery sections (Figure 2). An o-ring between the sections serves to maintain the housing's watertight integrity. Stainless steel latches maintain a constant pressure that pre-loads the o-ring and prevents leakage within specified depths. (Note: The upper and lower housings are a matched set; do not mix them up with those of other transceivers.)

2.3 TRANSCEIVER ADJUSTMENTS

The SSB-2010/1001B provides adjustment controls for Squelch, Voice-Operated Transmission (VOX), Side Audio Volume (SV), Receive Volume (RV), and channel selections. These adjustments can be made on the surface or while diving. The adjustment to all the above-mentioned modes is accomplished by depressing the PTT control (the location of which is different for each EM assembly) two times within one second. The transceiver will cycle to the voice menu mode, where adjustments can be made. This mode gives the diver the opportunity to customize his transceiver according to his diving profile. For further information on adjustment, refer to the operating instructions in Section 3.

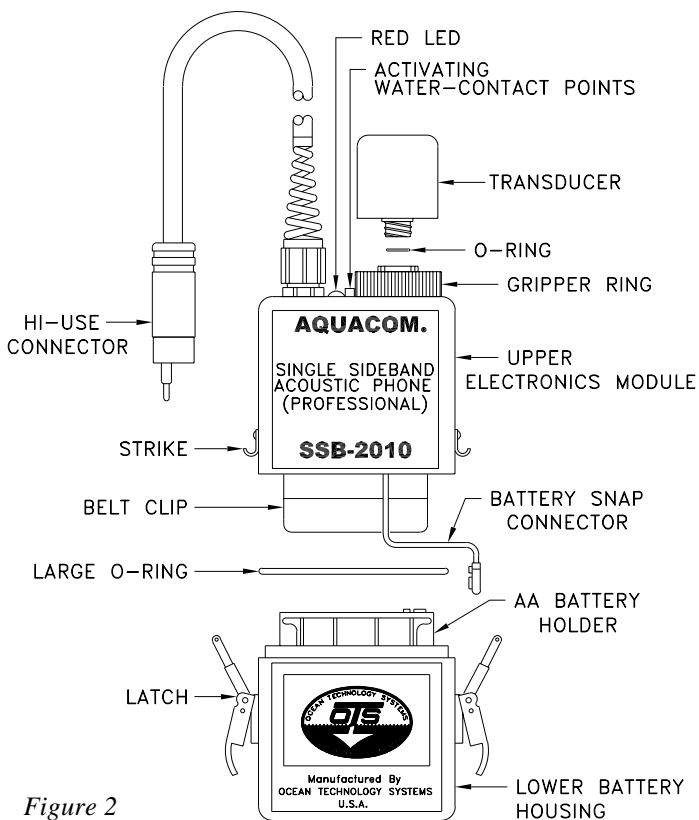

Figure 2

2.4 VOICE-OPERATED TRANSMITTER (VOX)

VOX operation provides hands-free communications. The user simply talks for the unit to transmit automatically. The VOX sensitivity needs to be set according to the diver's voice. If the VOX is not adjusted properly, either false transmission due to noise or an inability to transmit will occur. The user can deactivate the VOX and use push-to-talk by simply switching to the PTT mode via the voice adjustment mode.

2.5 MANUAL PUSH-TO-TALK SWITCH (PTT)

A unique feature of the Aquacom® SSBs is their ability to be electronically switched between the VOX and PTT modes while underwater. The

location of the PTT button varies between earphone/microphone assemblies. This variation is due to the many different configurations of full-face masks. When in the PTT mode, the user simply depresses the button to transmit. The system automatically returns to the receive mode upon release of the PTT button. The PTT function will override the VOX function. Refer to Section 3.3 (Adjusting the SSB-1001B/2010) for further instructions.

2.6 SQUELCH

The squelch provides a means to limit the background noise heard by the diver. The proper setting will depend on the specific requirements of the dive. If long range is desired, minimal or no squelch should be used. If working close-range to other divers and/or the surface station, an increased setting can be used. An increased setting will help eliminate man-made or marine biological noise. Remember, using squelch decreases range. If you do not use any squelch, you will obtain greater range.

2.7 SIDE AUDIO VOLUME

When you transmit, you will hear yourself via your earphone. This is called "*Side Audio*." It is useful for verifying you are transmitting. The "*Side Audio*" volume can be adjusted. Refer to the operating instructions (Section 3) for further information.

2.8 RECEIVER VOLUME

All incoming audio is called "*Receiver Volume*." Each diver hears a little differently and may like a loud or soft listening volume. Also, some full-face masks or helmets may have a configuration that causes feedback from the microphone/earphones. If this occurs, a lower setting may be desired. Refer to the operating instructions (Section 3) for further information.

2.9 MULTIPLE CHANNEL SELECTION

The SSB-1001B and SSB-2010 have the capability to operate on several different frequencies. We refer to these as channels. The SSB-1001B offers all eight (8) channels, and the SSB-2010 offers four (4) channels. Having the ability to select multiple channels is a feature useful for dive teams who have several teams or when one happens to be on the same

channel as another group. The diver can select channels on land or "on the fly" while diving. Refer to the operating instructions (Section 3) for further information.

The dive team should talk about channel switching before the dive operation. One channel should be picked as a fall-back channel in the event divers end up on different channels. If you cannot establish communications within a few minutes after it was decided to change channels, everyone should fall back to the predetermined base channel.

The following is a chart showing you the operating frequencies and corresponding channels:

Channel 1	=	32.768 kHz (upper sideband)
Channel 2	=	32.768 kHz (lower sideband)
Channel 3	=	31.250 kHz (upper sideband)
Channel 4	=	31.250 kHz (lower sideband)
Channel 5	=	28.5 kHz (upper sideband)
Channel 6	=	28.5 kHz (lower sideband)
Channel 7	=	25 kHz (upper sideband)
Channel 8	=	25 kHz (lower sideband)

2.10 RELATED COMPONENTS

2.10.1 Transducer: The transducer provides the "antenna" for the transceiver. It is removable via a connector mounted on the top of the housing. A large ring provides a means to easily remove and reinstall the transducer (Figure 2). When using the RB-11 nickel-metal hydride (NiMH) battery pack (optional with the SSB-2010), the transducer's housing connector is also utilized to charge the NiMH battery pack (see the Battery Installation and Charging section). This feature makes it easy to charge the NiMH battery pack without having to open the transceiver.

The SSB-2010 is supplied with one TA-5 (33-kHz) transducer. The SSB-1001B is supplied with one TA-4 (25-kHz) transducer. The transducer is the antenna used to receive and transmit a message. It is important that the transducer not be covered by any diving apparel or equipment.

TABLE 1: SSB-1001B/2010 COMPATIBILITY CHART

ModelNumber	Description	Mic.	Earphone		Mask Type
			Single	Dual	
EMA-2 (911060-001)	Ear./Mic. Assy.	Hot-Mic®		X	All MKII FFM
EMA-2SM (911060-098)	Ear./Mic. Assy.	Super Mic®		X	All MKII FFM
EMX-2 (911060-008)	Ear./Mic. Assy.	Hot-Mic®		X	EXO-26 FFM Original
EMX-2B (911060-026)	Ear./Mic. Assy.	Hot-Mic®		X	EXO-26 FFM Standard
EMO-2 (900096-686)	Ear./Mic. Assy.	Hot-Mic®		X	Ocean Reef FFM
EMH-1 (911060-009)	Ear./Mic. Assy.	Hot-Mic®	X		HM-2 Mouth Mask
CDK-6 (900015-007)	Portable Surface Kit, VOX or PTT	Boom		X	Surface headset
EMS-2 (911060-017)	Ear./Mic. Assy.	Hot-Mic®	X		Scuba Pro FFM
EMMT-1 (911060-090)	Ear./Mic. Assy.	Hot-Mic®	X		Mantis FFM
EMMT-2 (911060-091)	Ear./Mic. Assy.	Hot-Mic®		X	Mantis FFM
EMD-2 (911060-067)	Ear./Mic. Assy.	Hot-Mic®		X	M-48 FFM
EMDG-2 (911060-076)	Ear./Mic. Assy.	ME-500		X	Dräger Panorama Nova Dive Mask
EMH-MAG2 (900332-000)	Ear./Mic. Assy.	Hot-Mic®	X		HM-1 half mask
LAR-V® Adapter (900282-000)	Ear./Mic. Assy.	ME-500	X		LAR-V® rebreather

2.10.2 Earphone/Microphone Module (EM): Because each full-face mask (FFM) manufacturer has designed a different communication port for its masks, we have provided different earphone/microphone modules. The EM assemblies are an option with the SSB-2010. The SSB-1001B comes standard with one EMA-2 earphone/microphone assembly. Table 1 is a compatibility chart for earphone/microphone assemblies available for the SSB-2010 and SSB-1001B. *Note: If you have a diving helmet or FFM that is not on the compatibility chart, contact Ocean Technology Systems or your local OTS dealer to find out if it is available or for a quote to build a custom EM assembly.*

2.10.2.1 EMA-2 Earphone/Mic. Assembly (911060-001): The EMA-2 earphone/microphone assembly is designed for all Divator MKII full-face masks. It consists of dual ceramic earphones, two earphone holders, the ME-16R Hot-Mic®, a Hi-Use® connector, and a PTT button. The assembly is designed to install into the Divator MKII FFM communication port.

2.10.2.2 EMA-2SM Earphone/Mic. Assembly (911060-098): The EMA-2SM earphone/microphone assembly is designed to be installed into the Divator MKII full-face mask. It consists of dual ceramic earphones, two earphone holders, the Super Mic® (all-depth, floodable, noise-cancelling microphone), a Hi-Use® connector, and a PTT button. The assembly is designed to install into the Divator MKII FFM communication port.

2.10.2.3 EMX-2 Earphone/Mic. Assembly (911060-008): The EMX-2 earphone/microphone assembly is designed for the EXO-26 original full-face mask. It is similar to the EMA-2 but fits the EXO-26 and does not come with earphone holders.

2.10.2.4 EMX-2B Earphone/Mic. Assembly (911060-026): The EMX-2B earphone/microphone assembly is designed for the EXO-26 standard full-face mask. It is similar to the EMX-2 but fits the EXO-26 with an oral-nasal cavity and does not come with earphone holders.

2.10.2.5 EMO-2 Earphone/Mic. Assembly (900096-686): The EMO-2 earphone/microphone assembly is designed to install into the Ocean Reef NIRA Neptune full-face mask. It consists of two earphones, two earphone holders, a Hot-Mic®, a Hi-Use® connector, and a PTT button. It installs into a port located on the side of the FFM.

2.10.2.6 EMH-1 Earphone/Mic. Assembly (911060-009): The EMH-1 earphone/mic. assembly is designed to operate with the HM-2 mouth mask. It consists of one HM-2 mouth mask, one head strap, one ceramic earphone, a Hot-Mic®, a Hi-Use® connector, and a PTT button (located on the HM-2).

2.10.2.7 EMS-2 Earphone/Mic. Assembly (911060-017): The EMS-2 is an earphone/microphone assembly designed to be installed into a Scuba Pro full-face mask. It consists of two earphones and holders, a Hot-Mic®, a PTT control, and a Hi-Use® connector.

2.10.2.8 EMMT-1 Earphone/Mic. Assembly (911060-090): The EMMT-1 earphone/mic. assembly is designed to install into the Mantis full-face mask. It consists of one earphone, an earphone holder, a Hot-Mic®, a Hi-Use® connector, and a PTT button.

2.10.2.9 EMMT-2 Earphone/Mic. Assembly (911060-091): The EMMT-2 earphone/mic. assembly is designed to install into the Mantis full-face mask. It consists of two earphones, two earphone holders, a Hot-Mic®, a Hi-Use® connector, and a PTT button.

2.10.2.10 EMD-2 Earphone/Mic. Assembly (911060-067): The EMD-2 earphone/mic. assembly is designed to install into the M-48 full-face mask. It consists of two earphones, earphone holders, a Hot-Mic®, a Hi-Use® connector, and a PTT button.

2.10.2.11 EMDG-2 Earphone/Mic. Assembly (911060-076): The EMDG-2 earphone/microphone assembly is designed to be installed into the Dräger Panorama Nova Dive Mask. It consists of two earphones, earphone holders, an ME-500 microphone, a Hi-Use® connector, and a PTT button.

2.10.2.12 EMH-MAG2 Earphone/Mic. Assembly (900332-000): The EMH-MAG2 earphone/microphone assembly is designed to be installed into the HM-1 silicone half mask. It consists of one earphone, a Hot-Mic®, a Hi-Use® connector, and a PTT button.

2.10.2.13 LAR-V® Adapter Assembly (900282-000): This adapter is placed between the inhalation hose and LAR-V® bite-mouth SBV assembly. It is designed to allow basic words to be transmitted without the need for a full or half mask. It consists of one earphone, an ME-500 microphone, a Hi-Use® connector, and a PTT button.

2.11 MICROPHONES

2.11.1 ME-16R Hot-Mic® (912086-000): The ME-16R Hot-Mic® is a 150-ohm, water-resistant microphone element. It is a state-of-the art microphone element designed to give you long, trouble-free use and the highest intelligibility possible.

Although the Hot-Mic® is trouble free, it should be maintained. Rinse with

freshwater after use to get all dirt, debris, or salt water from the grill. Dry with a clean, soft towel. If the element ever needs to be replaced, it is easily removed by unscrewing the two small screws located on its base.

Getting the microphone wet does not harm the microphone. However, the microphone element can only withstand an 8- to 10-foot depth/pressure differential. If you removed your diving FFM at the back of the boat and the microphone became wet, there would be no problem; but if the FFM with element dropped more than 8 to 10 feet into the water, the change in pressure probably would damage the microphone element. In tests we have taken off the FFM at 30 feet and replaced it, still at 30 feet, without any problem; but if one were to take off the FFM at 30 feet and drop down to 40 feet, the pressure difference may damage the microphone.

2.11.2 Super Mic® Depth Master: The Super Mic® overcomes a limitation of other microphones. It can be used at any depth and—unlike the Hot-Mic® or many other microphones—can withstand changes in depth while submerged, so it will not be damaged if the diver needs to descend with the mask flooded. It has a compact, lightweight design and—like the Hot-Mic®—it is noise cancelling, reducing background noises to provide clearer communications. When only the highest quality of intelligibility is required, the Hot-Mic® is the preferred choice; however, the Super Mic®'s intelligibility is sufficient for most diving situations.

To assure clear communications when using the Super Mic®, it should be no more than 1/4 inches from the corner of the diver's mouth.

After each dive, clean the Super Mic® by rinsing it with freshwater and drying it with a clean, soft towel. No other maintenance is required.

2.12 COMPATIBLE SURFACE/DIVER TRANSCEIVERS

The SSB-1001B and SSB-2010 transmit to and receive from any transceiver set to the same frequency and within range. The following are OTS factory-compatible transceivers: STX-101, STX-101M, Buddy Phone® (e.g., XT-100, MKII-BUD, MTS-BUD, SCU-BUD, OR-BUD, DSI-BUD, and RX-100), SSB-2001B-2, MAG-1002D (high-frequency model), MAG-1003D, MAG-1004HS, MAG-1003-PS, SP-100, and the MAG-1001S (standard model).

SECTION 3

ADJUSTMENT & OPERATING INSTRUCTIONS

This section contains information for operating the Aquacom® SSB-2010 and SSB-1001B through-water transceivers.

3.1 INSPECTION OF EQUIPMENT

Upon arrival of the equipment, inspect the shipping container for dents, gouges, or any other evidence of rough handling.

The Aquacom® transceiver should be visually inspected upon removal from the shipping container. If any damage is evident, immediately file a claim with the carrier. Forward a copy of the damage claim to Ocean Technology Systems, Santa Ana, CA. Arrangements for repair or replacement will then be made.

Note: Although the Aquacom® SSB is rugged in design, care should be exercised to ensure that problems are not caused by improper handling. Store the unit in a safe, secure area after unpacking.

3.2 AQUACOM® SSB OPERATING PROCEDURES

STEP 1: Ensure fresh AA alkaline batteries are installed and that all o-rings are free of debris and in good condition. If using a nickel-metal hydride battery pack, refer to the Battery Installation and Charging section of this manual. Ensure the transducer has a small o-ring in place and is properly seated.

STEP 2: Ensure all internal settings are properly adjusted (i.e., Squelch, VOX, Side Audio, and Receive Audio) (see the adjustment procedures in Section 3.4).

STEP 3: Verify the battery snap wires have not been pinched from securing the upper and lower housings (*a pinched wire will cause flooding, which will damage the unit*).

STEP 4: Connect the Hi-Use® connector from the SSB-2010/1001B to the Hi-Use® connector on the FFM, helmet, or CDK-6 headset.

STEP 5: Locate the two activating water-contact screws on the top of the upper module between the transducer gripper ring and the red LED (Figure 2). Moisten your fingers and place them across the screws to activate the unit (hold onto the screws about 10 seconds). The unit will stay on for approximately 2 minutes out of water. The red LED will illuminate while power is on.

STEP 6: While the unit is still activated, depress the PTT button and talk into the mask microphone. You should hear yourself in the earphones. If using the system in the voice operation mode (VOX), use a vowel sound such as “AH” or say the number “FOUR” to trigger the VOX. You should hear your voice (Side Audio) in the earphone (refer to the adjustment procedure in Section 3.4.5.1 if the volume is too loud or soft). (Note: The SSB-1001B and 2010, when first initiated, always begin in the PTT mode.)

STEP 7: Verify your transceiver is on the same channel everyone else will be using, earphone volume levels are to your liking, the VOX setting is proper (if VOX is to be used), and the Squelch setting is proper for the environment and/or range you require. Refer to the adjustment procedures (Section 3.4) for assistance if necessary.

STEP 8: Repeat the above procedures with another transceiver and verify that it is operational and on the same channel.

STEP 9: Turn the Squelch off. Place both units into a sink or pail of water, or place transducer to transducer within 4 feet out of water; transmit between each unit. Verify that the units transmit and receive to each other.

Note: The units will not sound as clear during these tests as they will in open water. The units are factory set to start in the PTT mode, Squelch off, earphone volumes high, and Channel 7 for the SSB-1001B or Channel 1 for the SSB-2010.

3.3 ADJUSTING THE SSB-1001B/2010

3.3.1 Voice Adjustment Mode: The SSB-1001B and SSB-2010 have a unique feature that allows you to adjust the unit electronically either out of or in the water. If you depress the PTT button two times within one second, the transceiver enters a "Voice Adjustment Mode." You will hear in your earphones a voice offering you the following choices: *"Transmit, Channel, Squelch, Volume."* This message will continue until you make a selection by depressing the PTT button once when you hear your desired option. When you have completed your adjustments, you have the option to double- or triple-depress the PTT button quickly. A double click will take you directly out of the "Voice Adjustment Mode." Your transceiver will be in the receive mode. A triple click will tell the transceiver to play back all settings in your earphone. You can triple-click at any time if you want to know all your settings (Figure 3).

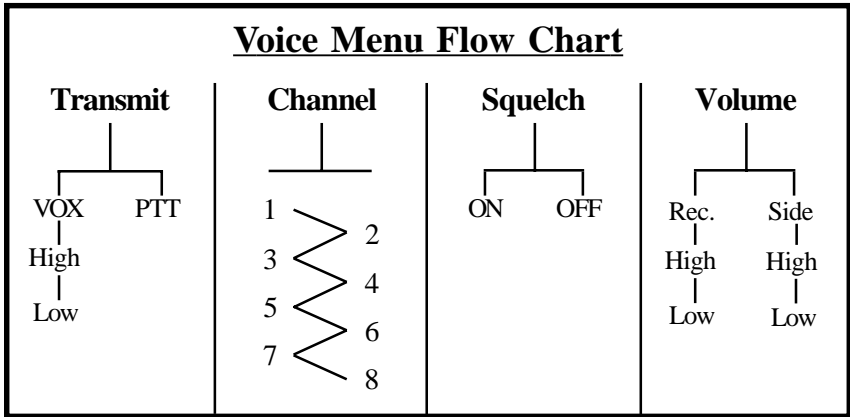

Figure 3

3.3.2 Push-to-Talk (PTT) Button: The PTT button serves a dual purpose: (1) When depressed and held, the transmitter is activated. As long as you hold the PTT button, you will be transmitting. When you release the button, your transceiver will automatically return to the receive mode. If you are in the VOX mode, you can still depress the PTT to override the VOX. This feature is useful if your VOX is not adjusted properly and you have trouble activating the VOX. However, if you override the VOX, when you release the PTT button, you will still have the VOX delay (see VOX Adjustment, Section 3.3.3.1). (2) As described in Section 3.3.1, use the PTT button to enter the Voice Adjustment Mode.

3.3.3 Transmit Adjustment: Access the Voice Adjustment Mode by depressing the PTT button twice within one second. You will hear the following in your earphone: *"Transmit, Channel, Squelch, Volume."* Depress your PTT once when you hear *"Transmit."* Your choices will be *"VOX, PTT."* Depress the PTT when you hear the setting you desire (see the VOX and PTT adjustment instructions below).

3.3.3.1 VOX Adjustment: Double-click the PTT within one second to enter the Voice Adjustment Mode. Depress the PTT button when you hear *"Transmit."* Depress the PTT one time when you hear *"VOX."* Next you will hear *"High, Low."* This message will repeat until you make a selection. Determine which setting is best for your dive profile. A high setting is more sensitive than a low setting. A proper setting will allow you to breathe without falsely triggering the unit. If during the dive you find your setting needs to be reset, follow the instructions above and try another setting, or switch to the PTT mode. After you have completed your VOX setting, you can stay in the program mode and set other functions or double-click or triple-click out (see Section 3.3.1).

3.3.3.2 PTT Adjustment: Double-click the PTT within one second to enter the Voice Adjustment Mode. Depress the PTT button when you hear *"Transmit."* Depress the PTT one time when you hear *"PTT."* You are now in the PTT mode. You can either make further selections or double/triple-click out.

3.3.4 Channels: To choose a channel, depress the PTT button two times within one second. Your transceiver will go into the "Voice Adjustment Mode." You will hear *"Transmit, Channel, Squelch, Volume"* in your earphone. When you hear *"Channel,"* depress the PTT button one time. The transceiver will offer you channels 1, 2, 3, and 4 (SSB-2010), or 1, 2, 3, 4, 5, 6, 7, and 8 (SSB-1001B), depending on which system you have purchased. Depress the PTT button when you hear the channel you want. After you have made a choice, the transceiver will continue with the next choice. You can either continue making other adjustments or double-click out (see Section 3.3.1). (Note: The most efficient channels are 1 and 2 for the SSB-2010 and 7 and 8 for the SSB-1001B.)

3.3.5 Squelch Adjustment: To adjust the Squelch on or off, double-click the PTT button within one second. The transceiver will go into the

program mode. When you hear the "*Squelch*" choice, depress your PTT button once. Your next choice will be either "*On*" or "*Off*." Depress the PTT button once when you hear the setting you want. You can now either continue with other setting choices or double-click out (see Sections 3.3.1 and 2.6).

3.3.6 Volume Adjustment: Depress the PTT button two times within one second. When you hear the "*Volume*" selection, depress the PTT button one time. You will now hear "*Receive, Side*." This message will repeat until you make a selection by depressing the PTT button one time.

3.3.6.1 Side Audio Adjustment: Enter the Voice Adjustment Mode by depressing the PTT button two times within one second. When you hear "*Volume*," depress the PTT button one time. You will hear two choices, "*Receive, Side*." Choose *side* by depressing the PTT button one time. You will hear "*High, Low*." This message will repeat until you make a selection by depressing the PTT once when you hear the desired selection. In some helmets or full-face masks, you may experience acoustic feedback while transmitting; in that case, a lower setting must be used.

3.3.6.2 Receive Volume: To adjust the Receive Audio listening level, depress the PTT button one time within one second. The unit will enter the Voice Adjustment Mode. Listen for the choice "*Volume*." Depress the PTT button once when you hear it. You will now hear "*Receive, Side*." Depress the PTT button one time when you hear "*Receive*." Listen for the setting you want. Your choice will be "*High*" or "*Low*," and the message will repeat until you make a selection. When you hear the setting you want, depress the PTT button once. Your transceiver will go back to the "*Side, Receive*" choice. You can now adjust your Side Volume or double- or triple-click out (see Section 3.3.1).

3.4 CDK-6 SURFACE ACCESSORY KIT

The SSB-2010 or SSB-1001B can be used as a portable surface station with the addition of the optional CDK-6 Surface Accessory Kit (Figure 4). The CDK-6 allows communications diver-to-surface, surface-to-diver, or surface-to-surface, assuming everyone has a transceiver operating on the same frequency and within range.

3.4.1 Installation of the CDK-6:

Installation is relatively simple. Remove the transducer located on the SSB-2010 or SSB-1001B by rotating the gripper ring (Figure 2) clockwise. Locate the male Amp connector on the transducer cable. Insert this end into the transducer's female Amp connector and slowly rotate until the cams line up. Rotate the small gripper ring located on the male Amp connector counterclockwise until you feel the o-ring. Then rotate it a little further, and you will feel the connector's seat.

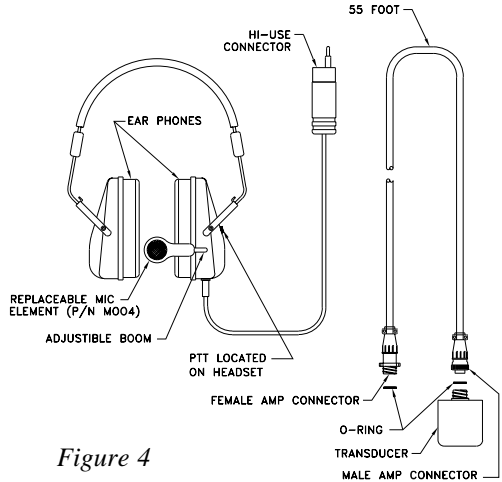

Figure 4

Rotate the small gripper ring located on the male Amp connector counterclockwise until you feel the o-ring. Then rotate it a little further, and you will feel the connector's seat.

Locate the female Amp connector on the transducer cable, and mate it to the male Amp connector located on the upper electronics module. Slowly rotate the large gripper ring counterclockwise until both connectors are seated (see Figure 4 for a CDK-6 component block diagram).

3.4.2 Push-to-Talk Mode: When using the CDK-6 in the PTT mode, simply depress the button located on the headset. The PTT mode is preferred to avoid VOX delay at the end of the transmission.

3.4.3 VOX Mode: When using the CDK-6 in the VOX mode, you must adjust the VOX control sensitivity so it will easily operate when you talk into the boom microphone. The boom microphone should be about 1/4" from your lips. Since it is a high-quality noise-canceling element, it will try to cancel noise or sound more than 1/4 inch away. The CKD-6 can be equipped with the Hot-Mic® waterproof element when the headset is used in a wet environment. However, the earphones must be kept as dry as possible.

CAUTION: Always check to ensure that the female Amp connectors have a good, clean o-ring in place before mating the connectors. Never twist the transducer body. Always use the large gripper ring

when removing the transducer. Damage will occur if you twist the transducer body without using the large gripper ring.

3.5 PRE-DIVE CHECKLIST

1. Fresh alkaline batteries or a fully charged NiMH battery pack installed.
2. O-rings in place, clamps secure (no pinched wires).
3. Diver unit in place, transducer free of diving equipment.
4. Bone conduction speaker adjusted and in holder.
5. Hi-Use® connector lightly greased and properly mated.
6. The diver is dressed out such that the wires will not snag, and the transducer is not covered by any type of diving equipment.
7. In-water surface check:
 - a. Recheck the location of the earphone.
 - b. Submerge the transducer.
 - c. Establish communication.
 - d. Look your dive partner over to ensure his equipment is properly adjusted and the wires are dressed so as not to snag.

NOTE: Your speech should be considerably slower than normal, and each word should be pronounced clearly and distinctly. Speak one word at a time instead of in flowing sentences. Do not shout, but use slightly louder than normal conversational volume. Minimize exhalation while speaking. Your communication will be more easily understood if you are relaxed, since speech is less intelligible as a diver becomes more anxious.

You should conduct a pool checkout and have further pool practice before using the system in open water. While Aquacom® provides divers with good underwater communications, it does not change or eliminate the potential hazards of diving!

CAUTION: Use any standard safe entry into the water, but be aware of the additional equipment you are wearing. The transceiver and cables should be positioned so they do not snag or hit against anything during entry. Keep a copy of this checklist handy for reference before entering the water.

3.6 RECEIVING A MESSAGE

When receiving a transmission:

- Relax.
- Concentrate on hearing.
- Try different earphone positions until the best one is found.
- Minimize exhalation bubble noise, but do not hold your breath.

Most divers find that an inhalation cycle is the best time to receive a message. While off-gassing, the bubble noise makes hearing difficult.

3.7 DOFFING THE DIVER UNITS

1. Disconnect the Hi-Use® connector from the full-face mask or HM-2 communications mask. Remove your mask. Remove your transceiver.
2. As soon as possible after each dive, rinse the unit in freshwater to remove salt and other mineral deposits.
3. Although the Aquacom® SSB is ruggedly constructed for long life in the marine environment, we strongly recommend that you place it in a protective carrying case between dives, taking special care to avoid damaging the transducer.
4. After using a CDK-6 Surface Conversion Kit, disconnect the transducer cable and reinstall the transducer onto the SSB. Rinse the transducer cable and the transducer with freshwater. Do not rinse the headset with boom microphone (the boom microphone is not waterproof). Instead, wipe it with a damp cloth.

3.8 EXAMPLES OF UNDERWATER COMMUNICATIONS

3.8.1 Calls Between Surface, Subs, or Divers: Listen for a break in conversation if others are communicating in the area. Identify whom you are calling and then identify yourself. Continue speaking until the message is complete. At the end of each message, say “OVER” if a response is required and “OUT” if no response is required.

Example

DIVER A: Red Diver, this is Blue Diver, do you see the wreck yet?
OVER.

DIVER B: Blue Diver, this is Red Diver, yes, I see the wreck, it's ten yards to your right. OUT.

3.8.2 Calls Between Divers and Surface, Subs, or Bells:

Example

DIVER A: Topside this is Red Diver, how far am I from the dive boats?
OVER.

SURFACE: Red Diver this is Topside, I see your bubbles 50 feet off my port bow. OUT.

DIVER A: Sub, this is Blue Diver, how long before I must lock in?
OVER.

SUB B: Blue Diver, this is Sub, we expect you in seven minutes.
OUT.

3.8.3 Calls Between Surface Units, Subs, and Bells: Surface units within range can communicate in open water or harbors, thereby avoiding the sometimes crowded and less private airways. Crews of submarines or bells can communicate with one another or with surface units in much the same way. It is recommended that standard radio/telephone procedures be used in all communications.

-IMPORTANT SAFETY NOTES -

It is absolutely essential for all divers to be properly trained and equipped before responding to distress, emergency, and safety calls.

WARNING: Under no circumstances should a diver begin an ascent while holding his breath (air embolism may occur).

SECTION 4

BATTERY INSTALLATION & CHARGING

The SSB-2010 comes standard with one SP-8 AA battery holder. Use eight AA alkaline batteries only. OTS also offers as an option the RB-11 nickel-metal hydride (NiMH) rechargeable battery pack and the RC-15 NiMH battery charger. International chargers are available.

The SSB-1001B comes standard with an RB-11 NiMH battery pack and an RC-15 battery charger.

4.1 SP-8, AA ALKALINE BATTERY HOLDER

The SSB-2010 is shipped with the SP-8 AA battery holder. It is located in the lower housing (Figure 5). To gain access, place the transceiver onto a stable surface and release the two latches securing the upper and lower housings (Figure 5); then separate the two. Load fresh alkaline AA batteries as per the directions stated on the SP-8. Ensure the main housing battery snap is securely fastened and no wires are pinched when reinstalling the lower housing.

4.2 RB-11 NIMH BATTERY PACK AND RC-15 CHARGER

The optional RB-11 NiMH battery replaces the SP-8. To install it, snap the RB-11 to the upper electronics battery snap.

It is not necessary to open the SSB-2010 to charge the RB-11. Remove the transducer (Section 3.4.1) and set it aside. Connect the RC-15 to the exposed transducer connector. A full charge requires approximately 14 hours. Replace the transducer (ensure the o-ring is in place and in good order).

Do not charge the batteries for more than 14 hours. Overcharging may cause excessive gas build-up. Before operating, allow a few minutes after charging for any gasses caused by charging to dissipate.

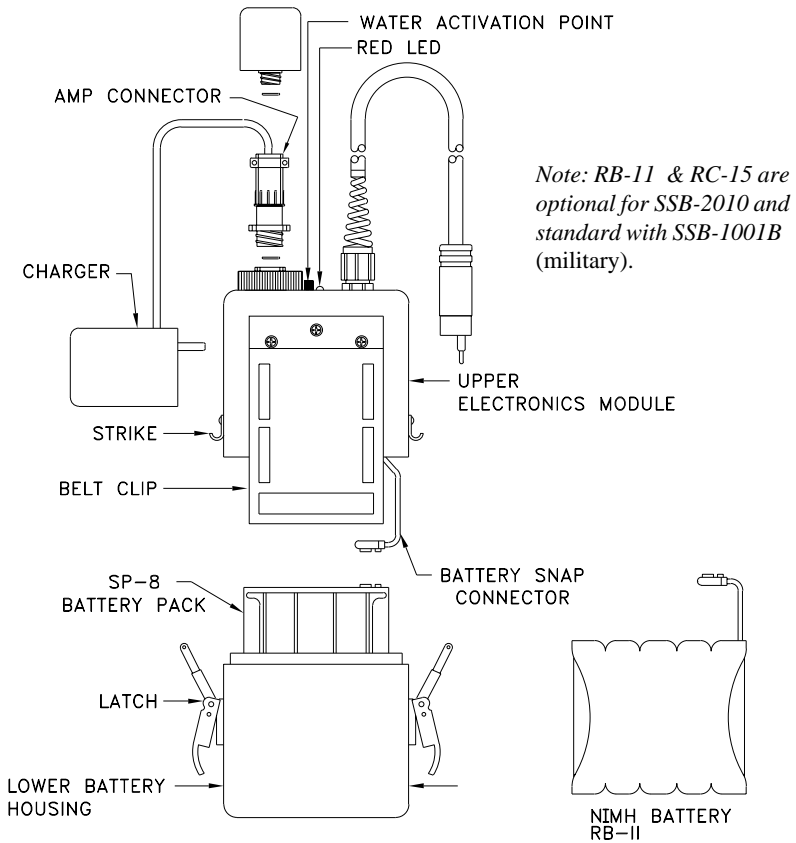

Figure 5

Note: When you receive your RB-11 rechargeable battery, it may have upgraded specifications from what is stated in this manual. Due to advancing battery technologies, we continually are upgrading our batteries and chargers. Contact OTS or your OTS dealer to find out the latest available battery and charger.

SECTION 5

MAINTENANCE & HELPFUL HINTS

5.1 GENERAL MAINTENANCE

The SSB-1001B and SSB-2010 are virtually maintenance free and should give you many years of service. The following should be done after each day of diving:

1. Freshwater-rinse to remove debris. A mild soap solution can be used, but after cleansing, rinse with freshwater.
2. Dry the transceiver with a clean towel, especially around the area of the activating water-contact screws. This will ensure the unit will shut off. Also ensure you dry the mask microphone. Note: The unit may take a few minutes to turn off; this is normal.
3. Store in a dry, safe area.

5.2 PERIODIC MAINTENANCE

The transceivers should have the following service performed periodically:

1. Clean and lightly grease the transducer and main housing *o-ring*. Check for cracks or damage. If there is any evidence, replace (do not grease the transducer).
2. Keep the transducer clean. Periodically wipe clean with alcohol (outside the shell).
3. Verify the battery snap screws are tight.
4. Verify the battery snap is in good order.

5.3 HELPFUL HINTS

Underwater communication is a useful tool and can save lives when used properly. Training is important and a must for new users. The following are a few helpful hints. Please review them and consider them when writing your training plan.

Note: This list is not in any order of priority.

1. Conduct initial underwater training in a controlled area, such as a swimming pool.
2. Speak slowly and pronounce each word clearly.
3. If working in a pool, make sure the pool does not have a bad or noisy pump. This would create millions of little tiny bubbles, which would kill the range. If after a few minutes you see tiny bubbles—like carbonation—gathering on your hands or dive gear, move to a new location. If the pump is noisy, secure it during the test.
4. Make sure the microphone elements are within 1/4" of the diver's lips.
5. Ensure all batteries are fresh (alkaline) or charged (rechargeable) before starting the dive operation.
6. Before the divers enter the water, check to make sure they have not covered the transducer with any type of dive gear.
7. Make sure all wires are dressed so as not to snag on things while diving.
8. Designate one diver as lead communication diver so both divers will not be trying to answer questions.
9. Brief the divers that after entering the water, especially if making a jump, they should make eye contact with the dive supervisor and establish communications (assuming you have a surface station).
10. During initial training, talk to one diver at a time until he establishes clear communications. Then talk to the other. After the divers are comfortable, have them talk to each other (assuming you have a surface station).
11. It is a good idea for everyone to agree on an alternate channel before the dive starts. In the event someone mixes up the channel to change to, everyone can go to the predetermined channel to reestablish communications.
12. If you feel a thermocline, report the depth to other divers and topside. Topside should adjust the transducer accordingly.

SECTION 6

ADVANCED USER INFORMATION

6.1 GENERAL

Although the SSB-2010/1001B is designed so that no manual adjustments are necessary, special adjustments are available. These adjustments allow the user to define the sensitivities of the VOX and squelch systems. Because no standards for design of full-face masks have been established, virtually all full-face masks have different internal designs. Some designs have little room for microphone installation, which makes it necessary to have a more sensitive setting. These advanced adjustments offer the user more options.

When a high or low setting is selected from the Voice Adjustment Menu for either the VOX or Squelch, your transceiver will give you a setting that is preset from the factory. If you find that you need more or less sensitivity, you can easily change the factory settings.

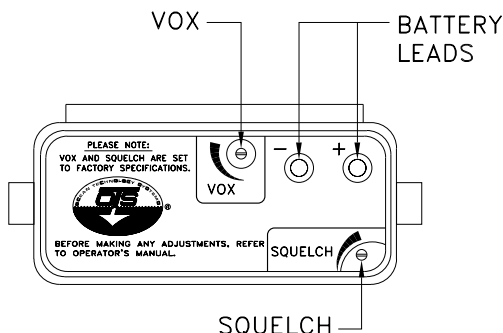

Figure 6

The master adjustment controls for the VOX and Squelch are located on the inside bottom of the upper electronics module. These are two-turn controls (Figure 6).

6.2 VOX

The VOX sensitivity control is located and marked on the bottom of the electronics compartment and can be observed after removing the lower battery compartment. The VOX control (Figure 6) will rotate two times and then stop. Clockwise rotation increases the sensitivity. If the "high" setting is too sensitive or not sensitive enough, rotate the adjusting control

Graph shows VOX High setting at one turn clockwise.

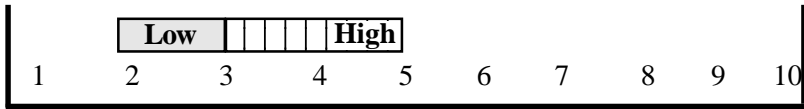

Note: This setting will give you a medium VOX sensitivity setting when set at High. This is our factory preset setting.

Figure 7

Graph shows VOX High setting at 1-1/2 turns clockwise.

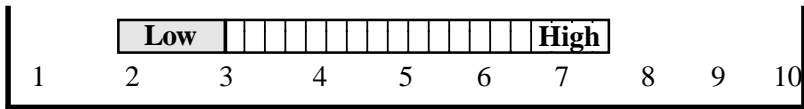

Note: VOX will trigger easy and may false trigger.

Figure 8

Graph shows VOX High setting at two turns clockwise.

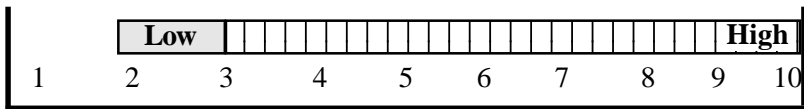

Note: We recommend this setting for the CDK-6 surface station only.

Figure 9

accordingly (see Figures 7–9 for a graphic look at effects of rotating the adjusting control). Divers should use the "low" VOX setting when using a Hot-Mic®. A "high" setting should be used when using the CDK-6 Surface Accessory Kit. This kit uses a headset with boom microphone and usually requires a higher VOX setting.

6.3 SQUELCH

The Squelch control (Figure 6) allows the squelch level to be varied. When the Squelch is on, the control acts like the squelch control on a CB radio. The Squelch adjustment control is a two-turn type. Clockwise turns from the beginning point will make the unit apply more squelch (Figures 10–12). The

more you apply squelch, the quieter the unit gets. It also reduces range. The factory-preset "ON" adjustment is set between 1/4 to 1/2 turns clockwise. When it is in the "ON" setting mode, the background noise should be suppressed. If you turn the control two turns clockwise, you will decrease your receive range dramatically. The divers will have to stay within a few feet of each other. In the event you cannot communicate due to excessive squelch, enter the Voice Adjustment Mode and set the transceiver to Squelch "OFF" until you can return to the surface to readjust.

Remember, the more squelch you apply, the less range you can expect. When possible, use the transceiver in the Squelch "OFF" position. The graphs in Figures 10–12 provide a visual representation of the Squelch settings.

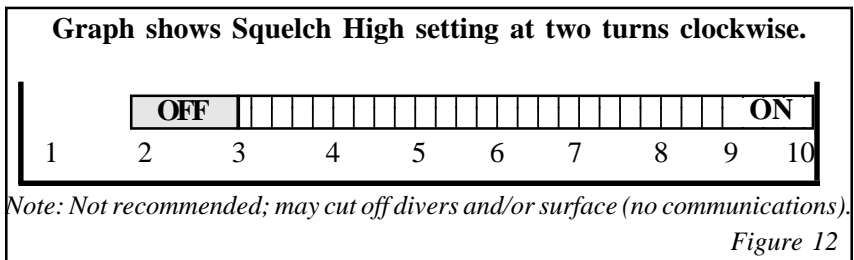
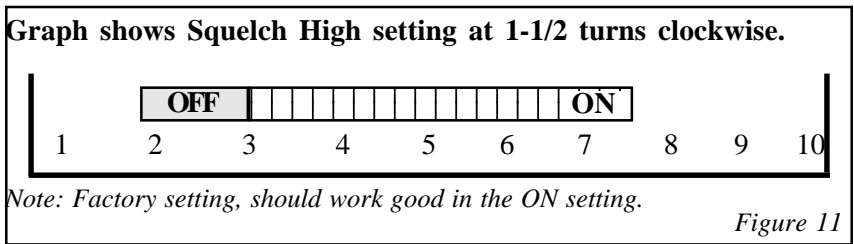
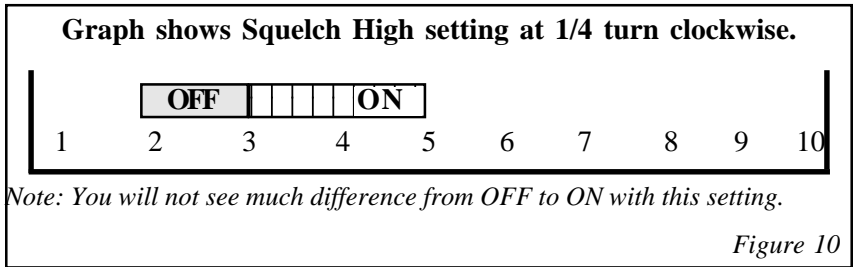

SECTION 7

BASICS OF SOUND IN WATER

7.1 BACKGROUND

If a diaphragm submerged in water is caused to vibrate by electrical means, it has mechanical energy of motion that is communicated to the water. If another diaphragm is submerged in the water near the vibrating diaphragm, the acoustic energy in the water will excite mechanical vibrations in the second diaphragm. These vibrations may be detected by electrical means to complete a flow of mechanical energy from the first diaphragm to the second. The first diaphragm is called the *source* or *transducer*, and the second is called a *receiver* or *hydrophone*. In Aquacom[®], the transducer and hydrophone are one and the same.

7.2 FACTORS THAT AFFECT SOUND IN WATER

There are many factors that affect the propagation of sound in water. All of these factors vary depending upon location, depth, and time of day. The net result is that communication in water can be affected by local conditions and the kind and depth of dive being conducted. Fluctuations in range and intelligibility are to be expected.

7.2.1 Distance: The sound intensity from a source varies inversely with the square of the distance from the source. This sort of variation is referred to as *spherical spreading*. Other factors also influence the variation of sound intensity with distance. As the sound passes through the water, some of the energy is absorbed and converted to heat (*attenuation*) and some of the energy is scattered by fish, pilings, seaweed, bubbles, etc. (*diffraction*). In addition, both the surface and bottom may affect the sound intensity by reflecting sound back into the water. The sound reflected by the surface and bottom may raise the intensity above normal levels (*reinforcement*) or may introduce *destructive interference*. The bending of the sound waves by temperature variations also has a great effect on the sound intensity at points remote from the source.

If the source of the sound is near the surface, there is some point beyond

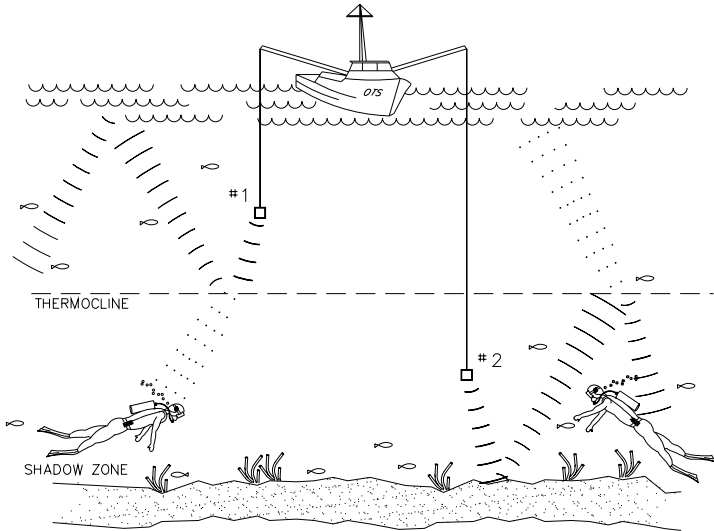

Figure 13: Thermoclines affect the ultrasonic signal. Divers must report thermocline depth(s) so the surface transceiver and/or other divers can be as close to the same depth as possible.

which sound is not received from the source. This point is said to be in a *shadow zone*. The distance from the source to the shadow zone is determined by the rate of change of temperature with depth, the depth of the source, and the depth at which the reception is made (Figure 13).

7.2.2 Water Density: In addition to these factors, water density is also important. Because the density of sea water varies with the temperature, the salt content, and the static pressure, the effect on sound of each of these three factors is usually considered separately.

7.2.3 Water Temperature: Variations in water temperature affect sound transmission most. In some areas of the ocean, the temperature changes at a fixed rate over large ranges of depth. If the temperature increases with depth at a fixed rate, the velocity of sound increases at a rate constant with depth and sound waves are refracted toward the surface. If, however, the temperature *decreases* with the depth (as is frequently the case), the velocity of sound decreases with depth and the waves of sound are bent downward.

There are also areas in the sea where, at some depth, temperature changes rapidly over a small depth range. Such a layer is referred to as a *thermocline* or *thermal layer*. Such layers, in addition to producing rather sharp bending of the sound waves by refraction effects, can serve as reflecting surfaces.

The velocity of sound transmission changes only about one percent for a temperature change of 10°F. However, the resultant bending of the sound path has great effect over a distance of several hundred yards.

If the temperature of the water decreases with depth at the rate of 1°F for each 30 feet (starting at the surface), most of the sound energy originating at the source near the surface will travel along paths that are bent rather sharply downward. Therefore, the sound energy may not reach a shallow detector positioned 1000 yards from the source but may reach a deeper detector position further from the source. Greater temperature variations can cause these paths to bend more sharply.

The best method to deal with thermoclines is to bring the divers and/or transducers as close to each other as possible. If a diver enters a thermocline, he should report it to everyone (surface and divers) so they know the depth of the thermocline. All divers should stay within that depth, and the surface station should try to position the surface transducer below or above, whichever is the case (Figure 13).

7.2.4 Background Noise: Marine organisms play an important role in underwater acoustics. They are important primarily because of the effect they have on sound transmission, but they often serve as sources of underwater noise as well. High background noise—whether man-made, animal, or environmental (waves or rain)—can interfere with good communications. Such background noise can be suppressed through the use of the squelch function and thermoclines.

7.2.5 Zones of Silence: Large natural or man-made objects can block acoustical transmission under certain conditions, in much the same way that a rock blocks a fast-moving current of water. Close to the backside of the rock, in this example, the current is absent and the water seems still. A short distance away, the current is flowing again (Figure 14).

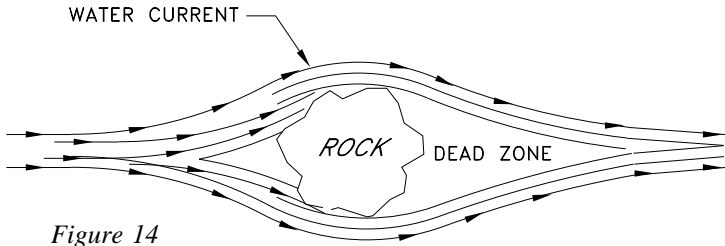

Figure 14

Similarly, acoustic energy in the water can be blocked if the transmitting source is close to a large object. On the backside of the blocking object, a “zone of silence” is formed in which reception of the transmitted signal is not possible. Divers can reduce “zones of silence” by moving away from, around, or above the blocking object until communication is reestablished (Figure 15).

Most single sideband signals are efficient enough to permit communications around blocking objects. Reception is made mainly through surface and bottom reflections. Man-made noise may be present underwater in busy harbors, shipping lanes, and many coastal locations, particularly at lower

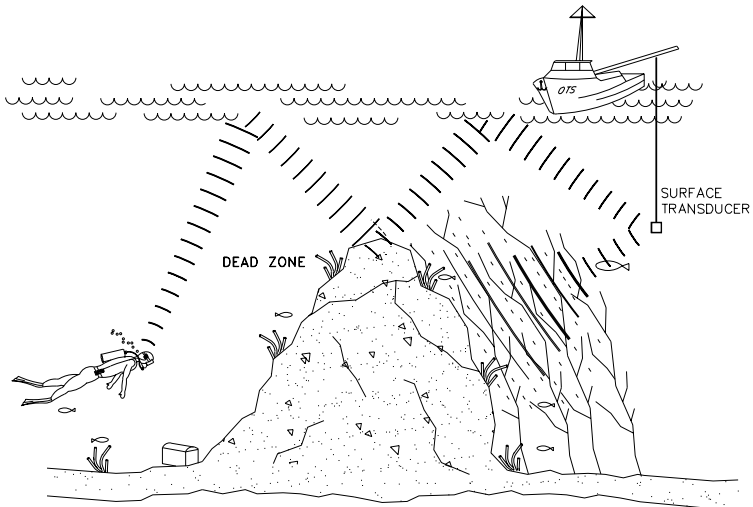

Figure 15: Communication through indirect and direct paths. Note help scattering sound. Without surface and bottom bounce, the diver would lose communications.

frequencies. The outstanding characteristic of this coastal ambient noise is its great variability from place to place in the same harbor and from time to time at the same place.

Under some conditions, when your diving suit is directly between the transmitting source and your Aquacom[®], a small zone of silence may be created that prevents reception. This effect becomes greater at longer ranges. Turning approximately 45 degrees in any direction eliminates this zone of silence.

Since most divers are in constant motion, it is unlikely that anything more than a momentary signal loss would occur when acoustic energy is blocked by air inside a dry suit, by gas bubbles within neoprene wet suit material, or when both are present—such as with a partially inflated dry suit.

- NOTE -

Now that you have read this operator's manual and have become familiar with the system, you are ready for your first communications dive. If you apply what you've learned—especially the proper positioning of the earphone and transducer and slow, deliberate, relaxed speech—you can look forward to a new dimension in underwater experience.

Undersea Systems International, Inc.

dba

Ocean Technology Systems

LIMITED WARRANTY

Ocean Technology Systems' SSB-1001B/2010 is fully warranted against defects in materials and workmanship for a period of 1 year from the time of purchase. Our obligation under this warranty is limited to the replacement of any part or parts which prove to our satisfaction to have been defective, and which have not been misused or carelessly handled. Labor is warranted for 1 year from time of purchase. The complete unit and/or part must be returned to our factory, transportation charges pre-paid. We reserve the right to decline responsibility where repairs have been made or attempted by other than an Ocean Technology Systems factory-trained service center or properly trained personnel. In no event shall Ocean Technology Systems be liable for consequential damages.

3133 Harvard Street, Santa Ana, CA 92704, USA

Telephone (714) 754-7848, Toll-Free (800) 550-1984, Fax (714) 966-1639

ots@oceantechnologiesystems.com, www.oceantechnologiesystems.com

©Copyright 1999 Ocean Technology Systems